

Characteristic Curves

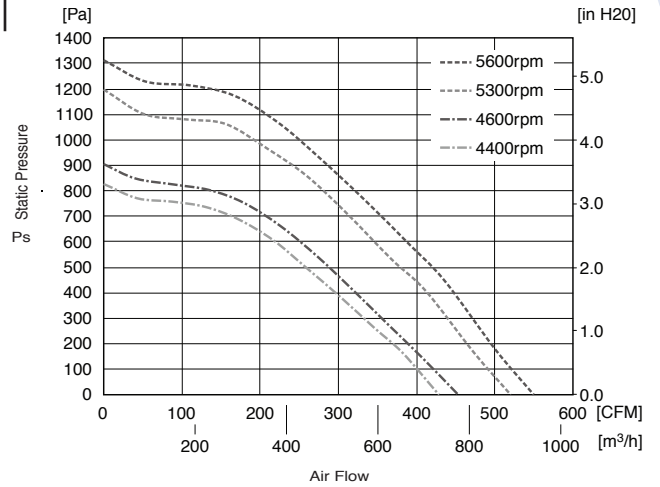

General Specifications

Motor Protection:

Locked Rotor, Reverse Polarity

Insulation Resistance:

10M Ω min measured with 500V DC between all leads shorted together and case

Dielectric Withstand Voltage: AC 500V 1 minute

Allowable Ambient Temperature Range:

-30°C ~ +70°C (Operating)
-40°C ~ +80°C (Storage)

Expected Life

L10 Life:

40°C 70,000 Hours

Material

Impeller : Plastic

Bearing : Ball Bearing

Lead Wire : UL1430, AWG18, +Red, -Black,
Speed Control = Yellow,
Speed Signal = White

Outline

Units: $\frac{[inch]}{mm}$

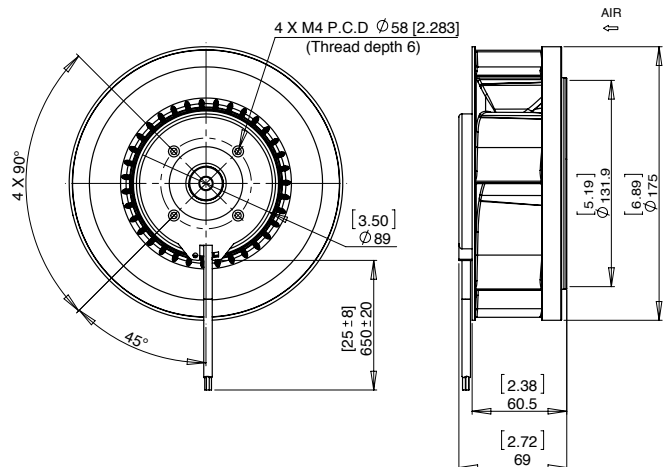

Specifications

MODEL	Rated Voltage	Operating Voltage	Current	Input Power	Speed	Max. Air Flow		Max. Static Pressure		Noise	Mass
	(V)	(V)	(A) ^{*1}	(W) ^{*1}	(min ⁻¹) ^{*1}	CFM ^{*1}	(m ³ /hr) ^{*1}	in H ₂ O	(Pa) ^{*1}	(dB) ^{*1}	(g)
F175H1-061-D0750	48	30 ~ 72	3.8	182.4	5400	625	1062	4.67	1167	78	900
F175H2-061-D0740	48	30 ~ 72	2.3	110.4	4500	514	873	3.37	843	73	900
F175H3-061-D0540	24	18 ~ 30	4.7	112.8	4700	541	919	3.65	913	74	900
F175H4-061-D0540	24	18 ~ 30	3.0	72	4000	455	773	2.60	651	71	900

Rotation: Clockwise looking at Air Inlet

*1: Average Values in Free Air and Rated Voltage Condition